

通用规格 (General specifications)

步距精度.....±5%
 温升.....80°C Max
 环境温度.....-20°C~+50°C
 绝缘电阻.....100M Ω Min 500VDC
 耐压.....500V AC 1minute
 径向跳动.....最大 0.02mm (450g 负载)
 轴向跳动.....最大 0.08mm (450g 负载)



电气规格 (Specifications)

型号	步距角	电机长度	保持转矩	额定电流	相电阻	相电感	转子惯量	电机重量
Model	Step Angle (°)	Length L(mm)	Holding Torque (N.m)	Current (A/Phase)	Resistance (Ω)	Inductance (mH)	Rotor inertia (g.cm ²)	Weight (Kg)
BS57HB41-02	1.8	41	0.39	2.0	1.4	1.4	120	0.45
BS57HB51-03		51	0.72	3.0	1.65	0.9	275	0.65
BS57HB56-03		56	0.9	3.0	0.75	1.1	300	0.7
BS57HB76-03		76	1.35	3.0	1.0	1.6	480	1.0
BS57HB84-03		85	1.8	3.0	1.45	3.0	520	
BS57HB112-03		112	2.0	3.0	2.2	3.5		1.5

外形尺寸 (Dimension)

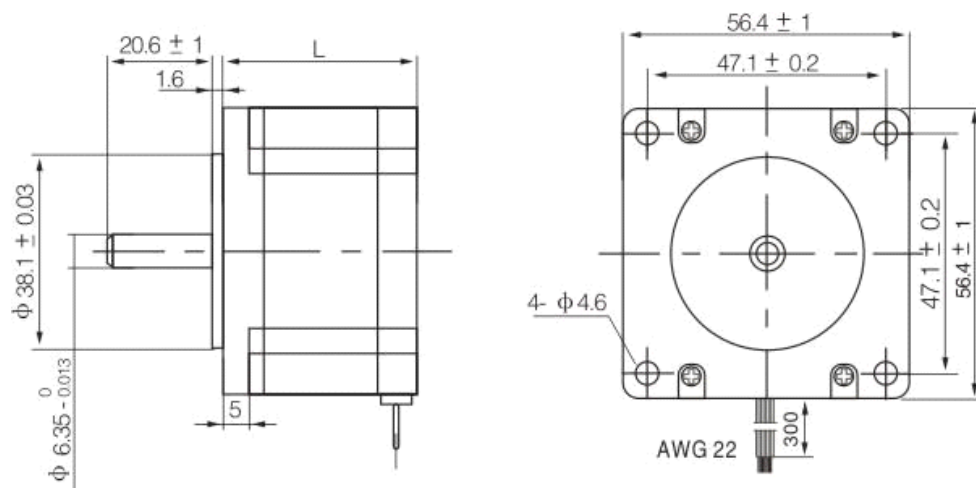

型号	轴径
BS57HB41-02	6.35mm
BS57HB51-03	6.35mm
BS57HB56-03	6.35mm
BS57HB76-03	6.35mm
BS57HB84-03	8mm
BS57HB112-03	8mm

矩频特性曲线图 (Frequency-torque characteristics)

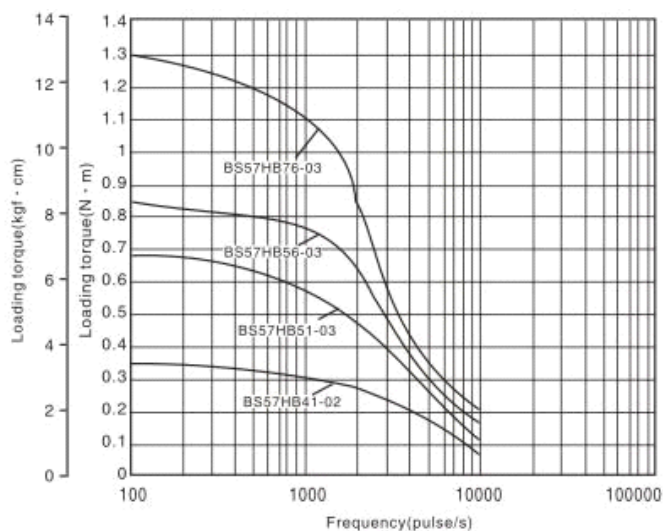

接线图 (Connections)

六出线 (6 leads)

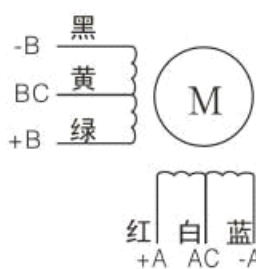

四出线 (4 leads)

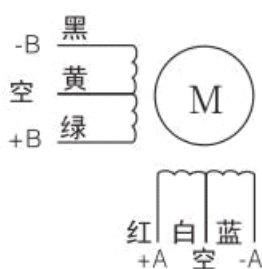

以上接线图适用 BS57HB41-02、BS57HB51-03、BS57HB56-03、BS57HB76-03 电机型号。

接线图 (Connections)

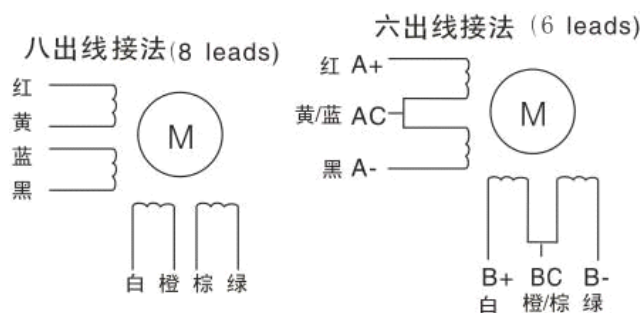

四出线接法(串联)

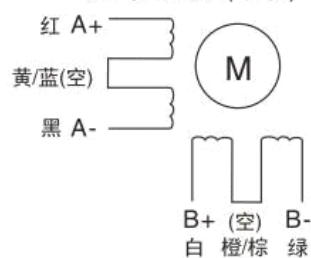

四出线接法(并联)

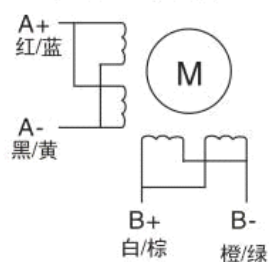

以上接线图适用 BS57HB84-03、BS57HB112-03 电机型号。